



## Kitemaking Essentials

Sewing machines:

Decent Thread

Good pair of scissors

1 metre ruler

Large Set Square

Pins

Means of marking cloth

Large table or floor space

Soldering Iron

Junior Hacksaw

Superglue

One that has a reverse button and does both straight and zigzag stitch is best

I use Güttermann polyester thread

I don't use mine for anything else, especially not for cutting paper

Glass headed ones are easiest to use

I use tailors chalk because it comes in different colours and is easy to rub out, but you can use a soft pencil. Do not use pen, felt tip or permanent marker!

The bigger the better!

For making holes for bridle line etc, you can use a large darning needle but this is quicker and easier on the fingers

For cutting spars

### For the kite itself

1.5m sq apr ripstop

3 x 1.2m apx of 6mm carbon tube

2 x 6mm dihedrals

2 x 6mm end caps

4 x 6mm arrow nocks

4 x 6mm C Clips

28cm apr 2 or 3mm carbon

30cm apx Dacron reinforcement

2.8m apx 150lb flying line

10cm bungee or heavy duty elastic

1 ring for the tow point

This needs to be a fairly decent quality, the spinnaker you can get from Chalkies or your favourite kite retailer for £3.00 a metre is fine and is 1.5m wide

Be careful what length you buy as there will be some wastage, you can buy either 3 x 1.5 m lengths or 2 x 2m lengths

If you haven't got any and your retailer hasn't got any suitable offcuts don't buy a whole length, give me a ring, I've got quite a few short lengths left over from other projects

For bridle and tensioning lines etc Never bridle a kite with line you would not fly on!

### Step 1 Drawing and Cutting out the sail

a) Lay the cloth face down on your table or floor. (Some ripstop is different on each side, if yours is then the shiniest side is the face.) Draw a line all the way up the centre of the back of the cloth. Make a mark on this line 5cm from one edge of the cloth. (Mark this edge the top to avoid any confusion later). 20cm further down from the mark you have just made draw a line at a right angle to the centre line, 60cm long on either side (120cm total length). A further 50cm down your center line, (That's 75cm from the top edge) draw a second line at right angles to the centre line, this time 52cm long on either side (104cm total). A further 6cm down the centre line (81cm from the top edge) draw a third line at right angles to the centre line, this one 60cm long on either side (120cm total length). Make a final mark on the centre line a further 40cm down (131cm from the top edge).

b) Join the marks and the ends of the lines together so you have two shapes like in the plan.

c) Many people feel happier if they have a separate line to cut to, so the next step is to draw a second parallel line 3cm outside the original all around your plan, preferably in a different colour. 3cm is a nice hem allowance for a beginner and it is also, conveniently, the width of most 1 metre metal rulers.

d) In the bottom left corner of the cloth outside the sail area there will be enough room to make the keel. Starting at the bottom, draw a 34cm line parallel to the left hand edge, 5cm away from the edge. Mark this line 3cm from the top of the line and again a further 26cm down (29cm from the top). Draw a second line parallel to this first line, 24cm away from the edge. Mark this second line 3cm from the top of the line again and a further 20cm down (23cm from the top of the line). Join these marks together so you have an irregular polygon shape for the keel. As with step "c" draw around this for a 3cm hem allowance.

f) Lastly, in the bottom right hand corner draw a rectangle measuring 3cm x 25cm. This will be used to connect the two sails together.

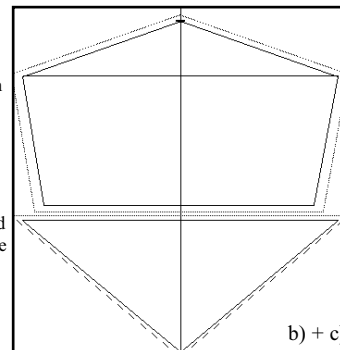
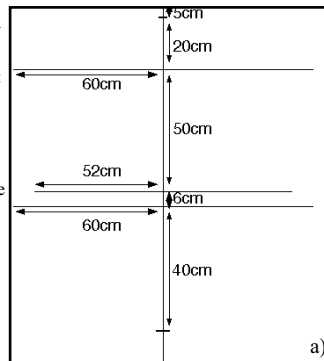

Now for the scary part. My dad was an engineer and he always told me "measure twice and cut once", and that goes for kite building too. Check your measurements, in particular make sure that each side of the centre line is the same and then cut out the sails and keel along the outer cutting lines, cut the long rectangle out as it is.

### Step 2 Sewing the Sail

- g) Sew a double hem all the way around the top sail first as it's the easiest. Set your sewing machine for a straight stitch with a stitch length of about 8 stitches an inch. Lay the sail face down and along one edge fold the fabric up half way between the edge and the drawn line. Fold it up again along the drawn line. This tucks the raw edge of the fabric into the hem and is much harder to describe than it is to actually do. Pin the hem as you go. Once you have pinned up one edge then sew it up on your machine before folding and pinning another edge. This is easier than trying to manage a sail full of pins. When starting or finishing a line of stitches always sew a few stitches forward, a few stitches backward and then a more few forward, this "locks" the stitches and prevents them from unraveling. Remove the pins as you are sewing, don't try to sew over them, your machine doesn't like it.
- h) Sew a double hem all the way around the bottom sail. To make the wing tip corners easier, fold in the points before folding the double hem.
- i) Double hem the shortest three sides of the keel.
- j) Fold the long rectangle into three lengthways and sew.

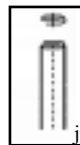
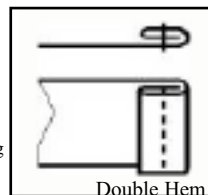

### Step 3 Pockets and Reinforcements

To attach the spars to the sail we are going to use pockets for the spine and arrow nocks for the cross spars.

- k) Cut two pieces of dacron reinforcement for the spine pockets, approx 3cm x 5cm and fold them not quite in half.
- l) Pin these into position on the back of the sail, sew and cut away the corner that extrude beyond the sail area.

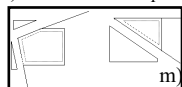

m) Cut 4 pieces of dacron for the wingtips, approx 4cm by 3cm, pin into position on the back of the sail, sew and cut away the excess.

n) Cut 2 pieces of dacron for the tensioning line reinforcement at the bottom corners of the top sail, approx 2cm by 2cm, pin into position of the back of the sail, sew and cut away the excess.

o) Cut 2 pieces of dacron for the keel spar pockets, approx 2cm by 3cm, fold not quite in half as per step "k", pin into position on the keel and sew.

p) Cut two pieces of dacron for the bridle points approx 2cm by 2cm, pin into position and sew.

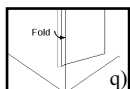

### Step 4 Attaching the Keel to the Bottom Sail

q) Draw a line down the centre on the front of the bottom sail. Align the plan line of the keel with this centre line, 5cm from the top. Pin into position and sew. Fold the excess material under into a hem, pin into position and sew.

### Step 5 Attaching the Sails together

r) Cut the strip into two equal lengths. Lay the sails out face down, 10cm apart. Position the strips 5cm either side of the centre line, pin and sew.

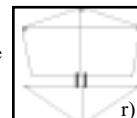

### Step 6 Making Holes for the Bridle Lines, Tensioning Lines and Spar Fixings

s) Heat up your soldering iron and make holes in the dacron reinforcement. Take care – it will also melt holes in your sail, fingers and carpets – **Soldering Irons get very hot and take a while to cool down!!!** You will need to make two holes for each of the spar fixings and one hole for each of the bridle points and tensioning lines. The sail is now complete

### Step 7 Cutting and Attaching the Spars

Another scary bit. Remember, measure twice – cut once. If in doubt always cut the spar longer than you think you need because you can always cut it again a bit shorter, you can't stick bits on to make it longer!

t) Keel Spar - as it is not under tension it does not really need end caps. Put one end of the 2mm or 3mm carbon or fibreglass in one of the keel pockets, line it up against the other keel pocket to measure it and cut to the right length with a junior hacksaw. When cutting carbon or fibreglass spars always rotate the spars as you cut them, this helps prevent the end splintering. Sand off any rough edges and fit the spar into both pockets.

u) Spine – the spine is under tension and will need end caps. End caps also help prevent the spar from piercing holes in the pockets during those unintentional hard landings. Lay the sail out flat on your table/floor, face down. Put an end cap on one of the 6mm carbon tubes and put this end into the spine pocket on the top sail. Line this up with the pocket on the bottom sail to measure it, allow a few millimetres for the bottom end cap and cut it to length. Sand off any rough edges. Slide on both dihedral fittings, put on the bottom end cap and fit the spar into both pockets. It will be a tight fit but once in position it doesn't have to come out again.

v) Cross spars – these fit between the spine and the wing tips. All four should be the same length. Slide the dihedrals into the correct position on the spine. Glue a C clip onto the spine, either side of the dihedral to keep it in place. Make sure the spine is lying central on the sail. Put one end of a 6mm carbon tube in the top left dihedral and align it with the top left wing tip, mark it 2cm past the edge of the wing tip. Put this spar in the other three positions to check they will all be about the same and then cut the four cross spars. If there is more than a small variation cut all the spars to the longest length. Insert all four of these into the dihedrals and put an arrow nock on each end.

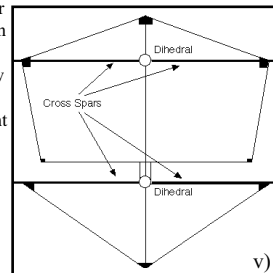

w) Cut 4 pieces of 150lb flying line into 10cm lengths. Always melt the ends of flying line to stop it unraveling. Thread one through

each of the wing tip reinforcements starting at the back of the sail, thread through one hole, across the front of the sail and back through the other hole. Tie this into an overhand loop so that all the loops fit over the arrow nock and hold the sail quite tightly.

#### Step 8 Bridle and Tensioning Lines

x) Tie an overhand knot in one end of the bungee or elastic and thread it through the keel reinforcement, then tie another overhand knot in the other end leaving 5cm between the knots. Cut 198cm of 150lb flying line and mark it 10cm from each end. Thread one end through the top sail reinforcement point, around the spine and back through the reinforcement. With the mark at the back of the spine tie an overhand loop in front of the sail. At the other end of the line fold the line on the mark and tie another overhand loop. Attach this to the bungee using a larkshead knot.

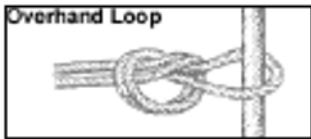

y) Attach the tow point ring to the bridle using a larkshead knot about a third of the way down from the top. This is only an approximation and will have to be adjusted on its test flight.



z) The corners of the top and bottom sail need to be attached together in such a way as their tension can be adjusted. You can use tensioning bars like those on tent guy ropes but I've found the easiest way is to use a larkshead and a series of overhand knots. Cut two pieces of line 10cm long and thread one through one of the holes on the lower wing tip and tie into an overhand loop.



Cut another two pieces of line 30cm long, thread one through each of the hole in the reinforcement on the bottom corners of the top sail and tie an overhand loop leaving a long tail on one side of the knot. Tie overhand knots every 1cm down this tail. Lay the kite on its front and larkshead the each of the loops on the bottom sail over the tail with the knots in so that the whole sail is held just taught. This is only an approximation and will have to be adjusted on its test flight.

#### Step 9 Flying your Kite

This is a kite for light winds and only needs 100lb line. The first time you fly the kite you will need to adjust the bridle and tensioning lines so that the kite flies straight. Adjustment of the tensioning lines is, unfortunately, by trail and error, you move up or down a knot and see if it improves the flight but after that – Enjoy!

Karen George